

COMPUTERIZED STATION FOR SEMI-AUTOMATED TESTING IMAGE INTENSIFIER TUBES

Krzysztof Chrzanowski^{1, 2)}

1) Military University of Technology, Institute of Optoelectronics, Kaliskiego 2, 00-908 Warsaw, Poland
(✉ kch@inframet.com, +48 22 666 8780)

2) INFRAMET, Graniczna 24, Kwirynów, 05-082 Stare Babice, Poland

Abstract

Testing of image intensifier tubes is still done using mostly manual methods due to a series of both technical and legal problems with test automation. Computerized stations for semi-automated testing of IITs are considered as novelty and are under continuous improvements. This paper presents a novel test station that enables semi-automated measurement of image intensifier tubes. Wide test capabilities and advanced design solutions rise the developed test station significantly above the current level of night vision metrology.

Keywords: image intensifiers, night vision, metrology.

© 2015 Polish Academy of Sciences. All rights reserved

1. Introduction

Image intensifier tubes (IITs) are vacuum tubes that amplify a low light-level image to observable levels. IITs are the most important components of night vision devices (NVDs).

NVDs for defense/security applications form the most important segment of night vision market. Therefore, it is not surprising that both general concept and methods for testing IITs were developed by military. These recommendations have been presented in a long series of MIL SPEC standards that regulate testing image intensifier tubes [1–6]. A set of almost thirty parameters was proposed to characterize IITs. However, practically a smaller set of no more than fourteen parameters (resolution, Modulation Transfer Function (MTF), Signal To Noise Ratio (SNR), Halo, blemishes (dark spots, bright spots, Multi to Multi Noise, Multi Boundary Noise, Chicken Wire), Image Non Alignment, Gross Distortion, Shear Distortion, Non-Uniformity, Photocathode Useful Diameter, Luminance Gain, Saturation Level, Equivalent Background Illumination (EBI), tube current) is measured during typical acceptance tests of potted, ready to use IITs.

Nowadays, MIL standards are at least partially accepted by manufacturers, test laboratories and final users of NVDs all over the world. The standards present recommendations for simple, non-computerized test stations for testing IITs. Recommendation to determine location and size of dark/bright spots of IITs by subjective human analysis of images generated by these tubes is one of examples of simplistic approach of these standards.

Such recommendations are logical because these standards were created several decades ago when computers were not available for metrology applications. Next, there has always been a pressure from military users for creations of compact, simple test stations.

Simple, compact, non-computerized test stations can be an optimal choice for final military users. However, big drawbacks of classical simple, non-computerized test stations are inherent low accuracy (high measurement errors), repeatability (dispersion of results of multiple measurements using the same test stations), low reproducibility (dispersion of results of multiple

measurements using a series of different test stations), a low test speed, and lack of possibility to record images generated by tested IITs. Therefore, at least twenty years ago it was concluded that more advanced testing of IITs using computerized test stations that enable automatic testing and digital recording of measurement results is needed. Several projects to develop computerized test stations have been carried out and a new generation of computerized systems is available [7–11]. This paper presents a computerized station for advanced testing of IITs. The station offers ultra wide test capabilities.

2. AIMS project

USA is the biggest military market for IITs. Evaluation of IITs purchased by military from domestic or foreign manufacturers has been always treated very seriously. Therefore, it is not surprising that the first report about work on computerized system for automatic inspection of image intensifier tubes was published by an US scientific team in April 1996 [7]. It was the first publication about the AIMS project (Automated Intensifier Measurement System). However, only after seven years later the first AIMS test station capable to be used for real machine vision automated testing of IITs was presented [8]. The developed test station has been found to be far from perfection and the project has been continued. A new test station for automated testing of IITs (coded as AIMS II) was reported in 2008 [9]. However, it took two more years before this new test station was officially deployed at the army depot [10]. Next, recent news suggest that the AIMS II test station is still in the evaluation phase [11].

AIMS II supports measurement of seven parameters of IITs: Modulation Transfer Function, Useful Diameter, Gross Distortion, Shear Distortion, Dark/Bright Spots, Luminance Gain, Uniformity. Therefore, it is clear that the system is not capable to measure several important parameters of IITs: SNR, resolution, Halo, Saturation Level, Image Non Alignment, EBI, tube current. Measurement of some of these parameters (SNR, EBI, resolution, tube current) is only planned to be added in the next phase of the AIMS project [9]. Therefore, it can be concluded that even after almost twenty years and investment of millions of USD the AIMS project has not produced a station capable to carry out automated expanded testing of IITs needed at typical acceptance tests.

The latter conclusion is not to minimize achievements of scientific teams that carried out AIMS project but to emphasize technical challenges that this team met and partially solved. It should be remembered that so far not a single scientific team in the world has developed a test station capable to do automatic acceptance tests of IITs. The test station to be presented in this paper can be used to carry out expanded acceptance testing of IITs, but the tests are done in semi-automated way.

3. ITS-IP project

ITS-IP (Image intensifier Test System – Imaging and Photometric parameters) is a code of a test system for semi-automated tests of IITs developed within the scientific project partially financed by a grant from the National Center for Research and Development of Republic of Poland (project no ZPB/72/65585/IT2/10) within period 2010–2014.

The aim of the ITS project has been to develop a single computerized test station capable to carry out typical acceptance tests of IITs (measurement of resolution, MTF, SNR, Halo, blemishes, Image Non Alignment, Gross Distortion, Shear Distortion, Non-Uniformity, Photocathode Useful Diameter, Luminance Gain, Saturation Level, EBI, tube current, and optionally Photocathode Luminous Sensitivity) in semi-automated way. This means that in contrast to the AIMS project it was accepted in the ITS-IP project that the human operator is still needed in measurement procedures. This is a significant relaxation of requirements on an ITS-IP station,

but new technical challenges were met in the ITS-IP project due to a bigger number of parameters to be measured.

4. Design of ITS-IP test station

Design of an ITS-IP station is based on the concept of a test station built from three main blocks:

- A calibrated image projector capable to project images of a series of standard targets to the photocathode plane of tested IITs and to regulate light intensity of projected images.
- A set of tools to measure image quality and light intensity at the screen plane of tested IITs.
- A PC set and software for semi-automated evaluation of data from measuring tools.

As shown in Fig. 1, the first block is built in a form of a stand-alone box that works as a light source, an image projector and a platform for measuring tools and PC accessories. This first block is coded as BM-IP base.

The set of measuring tools is built of an M-I microscope, a VM-I video microscope, a DC-I digital camera, an LP1 luminance probe, and an LP2 high sensitivity luminance probe. An optional CP current probe is added if Photocathode Luminous Sensitivity (test of bare tubes) is to be measured, too.

The third block is a typical PC desktop, an analog video frame grabber and a set of computer programs for supporting the measurement process: TAS-I software, ITS Display software, MC Viewer software.

The first program enables semi-automated analysis of images acquired from the VM-I video microscope and the DC-I digital camera. This program is needed for measurement of imaging parameters like MTF, SNR, Halo, blemishes, Image Non Alignment, Gross Distortion, Shear Distortion, Non-Uniformity and Photocathode Useful Diameter.

The second program enables to control the light source in the BM-I base module and to acquire signals from the LP1/LP2 luminance probes. This program is needed for measurement of photometric parameters like Luminance Gain, Saturation Level, EBI, tube current.

Finally, the third program provides the software support during measurement of resolution.

The human operator decides which parameter of IIT is to be measured and, accordingly, chooses a proper measuring tool, as shown in Table 1. Exemplary images of different targets generated by the tested IITs are shown in Fig. 2. The detailed technical parameters of the ITS-IP test station modules are presented in [12].

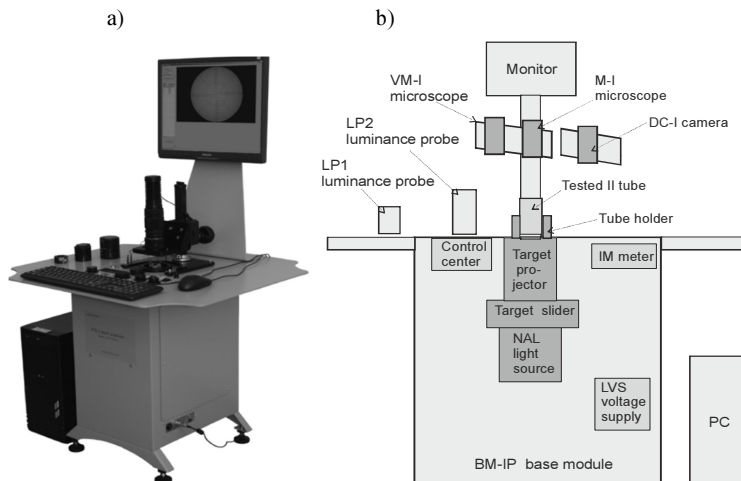

Fig. 1. The ITS-I test station: a) a photo; b) a block diagram.

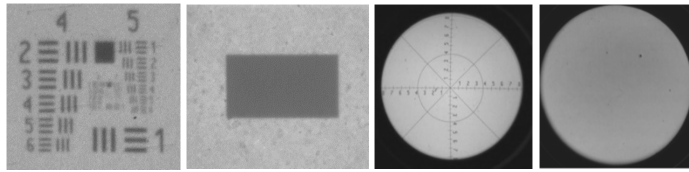

Fig. 2. The exemplary images of different targets recorded using the ITS-IP station.

Table 1. The list of parameters that can be measured with a suitable measuring tool.

No.	Measuring tool	Parameters to be measured
1	VM-I video microscope	resolution, MTF, SNR, Halo, Image Non Alignment, Shear Distortion, Non-Uniformity, Photocathode Useful Diameter, tube current
2	DC-I digital camera	blemishes (dark spots, bright spots, Multi to Multi Noise, Multi Boundary Noise, Chicken Wire), Gross Distortion, Non-Uniformity, Photocathode Useful Diameter
3	M-I microscope	Resolution (option)
4	LP1 luminance probe	Luminance Gain, Saturation Level
5	LP2 luminance probe	Equivalent Background Illumination (EBI)
6	CP current probe	Photocathode Luminous Sensitivity

Design of the ITS-IP test station based on a calibrated image projector and a set of exchangeable measuring tools looks apparently simple. Practically, successful design of this station requires to solve a long series of technical challenges. The most important ones are listed below:

1. An image projector of ultra-high resolution.
2. A light source of ultra-high dynamics.
3. An algorithm for measurement of MTF.
4. An algorithm for measurement of blemishes.

5. Image projector

The task of an image projector is to project images of several exchangeable targets (USAF1951 pattern, edge/slit pattern, pinhole pattern, tube diameter pattern, gross/shear distortion) on the photocathode of tested IITs with a negligible loss of image quality. The photocathode diameter of modern IITs can be as high as 25 mm. Such a big sensor area practically eliminates microscope objectives and objectives for video cameras as potential candidates to be used as objectives in the required image projector. Photographic objectives for analog cameras fit well from the point of view of the sensor area, because these objectives were developed to cooperate with 35x24 mm films and such analog photographic objectives in form of myriads of different designs are available on the market. However, the situation is not so simple.

It is commonly accepted by optical community that the resolution of an image projector must be several times higher (at least 5 times) than the resolution in the full area of tested IITs. Whereas the resolution of modern IITs can be as high as 81 lp/mm, the resolution of a required macro objective to be used as an image projector should be at least 405 lp/mm. However, the resolution of commonly available objectives for analog photographic cameras is not higher than about 56 lp/mm [13]. It is much below the earlier mentioned requirement. Further contacts with different manufacturers of photographic analog objectives confirmed that these objectives were designed to achieve the resolution not exceeding 100 lp/mm. Commercial macro objectives of the resolution over 400 lp/mm are not known on the market.

Another, roughly equivalent condition for an image projector is that the modulation transfer

function (MTF) of image projector should not be lower than about 0.7. The MTF data of even modern photographic objectives designed for digital cameras (a smaller sensor area comparing to the IIT area) show that the MTF of such objectives drops below 0.7 at 40 lp/mm [14].

The conclusion is that commercially available macro objectives capable to cooperate with IITs sensors are not available. In this situation a new customized macro objective has been developed. It is a twelve lens objective based on the quadro Gauss concept of the following parameters: magnification 1:1; NA = 0.125; spectral band 400–900 nm, back focal length 45 mm (Fig. 3). Tests of the developed objective confirmed that it fulfills requirements on both its resolution and MTF. As it can be seen in Fig. 4, the fifth element of group no 8 of the USAF 1951 resolution target (the spatial frequency 406 lp/mm) can be resolved. Next, the on axis MTF is clearly over 0.7 at 81 lp/mm. The off axis MTF is slightly below 0.7 level, but such a situation can be considered as acceptable as the off-center resolution of IITs is typically at least 10% lower comparing to the center resolution.

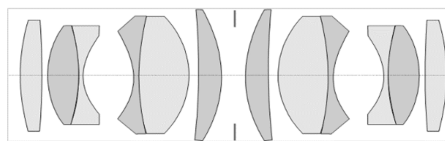

Fig. 3. An optical diagram of the optical macro objective used as the image projector in the ITS-IP test station.

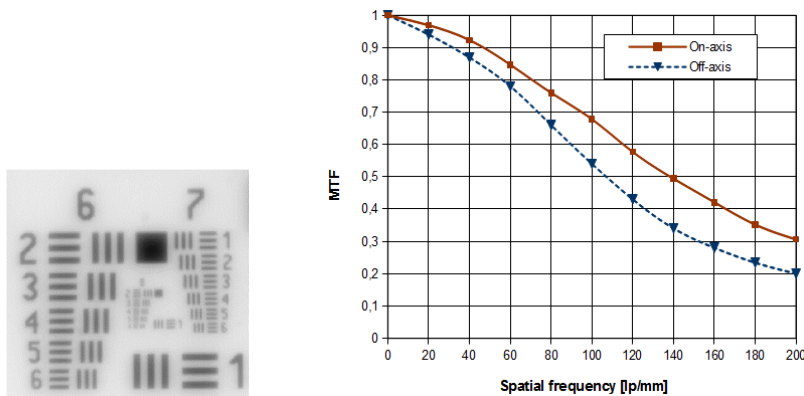

Fig. 4. The test results of the macro objective: the image of USAF 1951 target projected by the objective (left), the MTF measurement results (right).

6. Light source

Design of a calibrated light source for the station for testing IITs is a technical challenge, because at the same time several conditions must be fulfilled.

The first and the most important is the requirement that the light source must be capable to simulate light levels needed to measure all parameters of IITs in situation when tests must be sometimes carried out at extremely different conditions.

According to the recommendations of MIL standards tests of the high level resolution should be carried out at 200 lx. Next, EBI of modern IITs can be as low as 50 nlx and therefore measurement of this parameter should be done using a light source capable to regulate light intensity with the resolution not worse than 10nlx. These two values mean that a light source capable to simulate scenery of illumination regulated from 10 nlx to 200 lx is needed ($2 \cdot 10^{10}$ regulation dynamic).

On the market there are many offers of light sources with the illuminance range from 0 lx to over 10000 lx. However, practically the level of 0 lx is achieved by switching off such a light source, and the regulation resolution is ten thousands higher than the required value, so that such offers cannot be treated seriously.

Manufacturers of professional light sources typically specify the minimal and maximal output luminance as well as the regulation resolution. However, analyzing light sources from the latter group shows that none of light sources commercially available on the market [15–19] fulfills the earlier presented requirements. The main problem is minimal luminance level and regulation resolution. These parameters in the case of commercially available light sources are from 50 to over 50000 times higher than the required values. Therefore, it was decided to develop a light source optimized to use as part of the station for testing IITs.

Typical commercially available light sources used as reference sources in testing night vision devices, IITs and VIS-NIR cameras, are the sources that use a halogen lamp of 2856 K color temperature integrated with an optic-mechanical attenuator. The latter module enables precise regulation of light intensity without changing the spectrum of the light source. Use of such halogen-based light sources is fully in agreement with the recommendations of MIL standards that regulate testing IITs [1–5].

The analysis of design of light sources based on the concept of a halogen bulb integrated with optic-mechanical attenuators, carried out by the project team, has shown that it is technically possible to develop such a light source for the required illuminance range. In detail, a halogen light source of ultra-high dynamics has been developed as an additional product of this project [20]. However, it was decided that the new type of light source is needed in systems for testing IITs.

A wide spectrum, good regulation precision and potentially high dynamics are big advantages of light sources built using the concept of a halogen bulb integrated with a mechanical attenuator (or several attenuators). However, there are also two main disadvantages of this type of reference light sources. First, these light sources are slow, as precise, slow movement of the mechanical attenuator is needed to vary light intensity (minutes needed to scan the entire luminance range). Second, the halogen light sources are vulnerable to temporary variations of the halogen spectrum with time (after about a thousand hours).

Image intensifier tubes are manufactured in big numbers and can be considered as mass production. Therefore, the test speed is an important criterion of a test station and the analyzed light source should be considered as too slow. Next, the light source is used throughout full working hours every day; therefore, even after 1–2 months a spectrum deterioration can be expected and the bulb should be exchanged and the station recalibrated. This recalibration interval must be considered as too short. Therefore, it was decided to develop a new light source without these disadvantages.

This new light source coded as NAL is based on a concept of a dual channel light source built by combining two switchable light sources (Fig. 5):

- a) a non-regulated (or regulated in a narrow band of light intensity) broadband halogen light source of 2856K color temperature;
- b) an electronically regulated monochromatic LED source.

Mode B is the main work mode. Mode A is used only to recalibrate mode B (LED mode) to simulate the 2856K color temperature light source. It can be also optionally used during measurement of the luminance gain of IITs.

Because the halogen bulb of NAL light source is rarely used, temporary variations of the spectrum of mode A are slow. Mode B is used much more frequently, but due to inherent properties of LED sources temporary spectrum variations are negligible. Next, a high stability silicon photodiode with the spectrum optimized to simulate the spectrum of Gen 3 IITs is used to monitor the light intensity generated by NAL in both modes.

A combination of all these factors created the situation that the NAL source is very stable from the metrological point of view. The tests showed that variations of metrological properties of the NAL light source within one year period are negligible assuming typical working hours. Next, the NAL source working in mode B enables quick regulation of the light intensity in the full range (the response time is below 20 sec).

The concept of dual channel light source used in this paper is a modification of a concept to replace short lifetime, bulky halogen bulbs by LED light sources in stations for testing IITs that was presented in [21] several years ago. The trend to replace mechanically controlled halogen based light sources by electronically controlled LED sources can be also noticed in the case of equipment for testing color cameras [22].

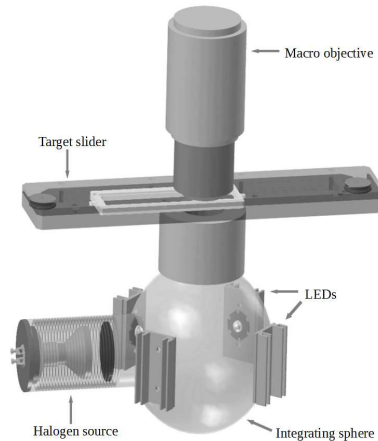

Fig. 5. A 3D drawing of the NAL light source.

The discussed concept of dual channel light source eliminated two drawbacks of typical single channel halogen light sources: a too short recalibration period and a too low regulation speed. However, this new design concept cannot directly help solve the third problem: how to achieve the desired ultra-high regulation dynamics. LEDs are not very stable at ultra-low input currents. It is not technically possible to achieve the required regulation dynamics at the level $2 \cdot 10^{10}$ using a single LED source. The ultra-high dynamics problem was solved by designing a special three stage LED source. In detail, three separate LED modules integrated with three attenuators of different attenuation are used. Module 1 covers the illuminance range from about 10 nlx to about 0.1 mlx, module 2 – the range from 0.1 mlx to 1 lx, and module 3 – the range from 0.1 lx to 200 lx. This 3-stage LED source creates some difficulties for control electronics, but the required ultra-high regulation dynamics has been achieved.

The technical problems of calibration of the NAL source are the same as described in [23].

7. MTF measurement methodology

The problem of measurement of the modulation transfer function (MTF) of image intensifier tubes has a relatively long history starting at the beginning of 1980s. A series of scientific papers on this subject have been published [7, 23–28]. All these papers propose determination of the MTF by analysis of generated by tested IITs image of a special reference test target, but propose different targets (narrow slit target, edge target, slanted edge target, Ronchi line target) and – consequently – different mathematical algorithms. There are also commercially available stations that offer measurement of the MTF of IITs by analyzing images of narrow slit/edge

targets [29–30].

In spite of this apparently rich literature and commercially available MTF test stations, development of an MTF test module in the ITS-IP station was a technical challenge due to two main reasons.

First, practically all literature sources dealing with the MTF measurement report that measurement of this parameter is sensitive to noise, particularly in the case of edge target/slanted edge target methods. Experiments carried out by the ITS project team confirmed that without additional noise reduction algorithms all mentioned earlier MTF measurement methods cannot generate repeatable and accurate results. The dispersion range of MTF results in the medium frequency range can be even as high as ± 0.07 .

Second, the mentioned earlier commercially available test stations offer only the measurement of MTF, whereas the task of ITS-IP station is to measure a long series of parameters of IITs. At the same time these commercial test stations are flexible modular stations built on typical big tables. This solution is convenient for designers, but creates ergonomic limitations for its users not working in a convenient sitting position.

The ITS-IP station uses a measurement method that differs significantly from methods used by test stations reported in [23–28]. In the ITS-IP station a classical MTF measurement method based on analyzing the image of a reference target was fused with a noise spectrum method. In other words, the MTF of tested IIT is measured using two methods, and later the final MTF is calculated by fusion of two measured functions.

The first method is a classical MTF measurement method based on analyzing the image of the edge target. The second method is based on a concept of calculating the MTF by analyzing the noise power spectrum of noise (NPS) present in the image of uniform scenery (uniform target). The final MTF is calculated by averaging two measured MTF functions using an experimentally determined weight averaging algorithm. The latter algorithm was developed on basis of analyzing the MTF measurement results of dozens of real IITs and hundreds of simulated IITs. In short, it can be said that in the low frequency band the final MTF results are similar to the results generated by the edge-response method, whereas in the high frequency range they are similar to the results generated by the noise – response method.

The edge-response method is known and used for decades. The noise spectrum method is new in the night vision metrology. This method has been successfully used in digital radiology for over a decade [31]. Therefore, the achievement of the ITS project team is modest and limited to combining two already known MTF measurement methods, but in a different technology field.

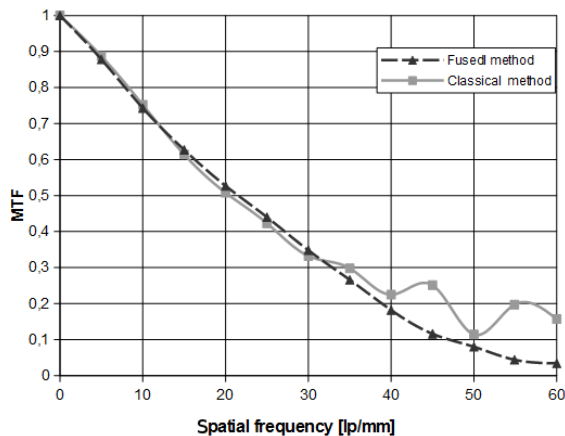

Fig. 6. The MTF measurement results of an exemplary IIT obtained using two measurement methods.

As can be seen in Fig. 6, the MTF determined using the classical edge-response method oscillates at frequencies over about 30 lp/mm and the MTF values are non-realistic. This effect originates from noise present in the image of the edge target. However, the oscillations are not present in the results generated by the new fused method. Therefore, it can be said that the fused method enables to determine the MTF of IITs with a negligible noise influence at the spatial region of up to about 60 lp/mm. It is much more than MIL standards require (measurements up to 15 lp/mm) and more than the MTF in typical data sheets (up to 30 lp/mm). Such a wide spatial frequency range at which the MTF can be measured creates potential possibilities for automatic determination of resolution of IITs, but this possibility must be further explored.

8. Measurement of blemishes

In spite of a big technological progress in image intensifier technology during last several decades blemishes of different types can be found in images generated by every IIT. There is only a question to be answered: how many of them, how big they are, and where they are located. The answer is important, because blemishes can act as visual distractions and may be large enough to mask critical information in images generated by IITs.

There are five types of blemishes present in images generated by IITs: dark spots, white spots, chicken wire, multi-to-multi pattern noise (MMPN), and multi-boundary pattern noise (MBPN). Dark spots are the most common type of blemishes present in images generated by IITs. These defects are defined as the opaque/dark or white spots which exceed contrast of 30 percent of their surrounding area.

It is typically required that the dark spots shall not exceed the size and quantities specified in special tables presented in MIL standards or other documents. The requirements differ depending on the spot location. The requirements are the highest for the center of field of view; the lowest – at the edges of field of view.

MIL standards that regulate testing IITs [1–6] directly propose determination of numbers and location of dark spots by subjective evaluation of images of a uniform target generated by tested IITs with help of a magnifying glass. Practically, numbers and location of dark spots were determined in old test stations by subjective evaluation of images of a uniform target with a set of artificial blemishes in three circular zones. Humans can achieve high accuracy in comparing real dark spots with artificial ones. Therefore, this classical subjective method worked quite well for several decades. However, this method is extremely time consuming and in the era of computer technology and machine vision capabilities must be considered as archaic.

Table 2. Exemplary requirements on dark spots.

Size of spots (μm)	Number of spots within 5.8 mm diameter circle	Number of spots within annulus bounded by two circles 5.8 mm and 14.7 mm diameter	Number of spots within annulus bounded by two circles 14.7 and total screen diameter
>300 μm	0	0	0
150 μm to 300 μm	0	1	2
75 μm to 150 μm	0	2	3
<75 μm	any amount	any amount	any amount

It is surprising to find that the problem of automatic determination of numbers and location of dark spots and other blemishes has received so far very little attention from international

community. Practically, the only published papers dealing with this problem are connected with the AIMS project carried out in USA [7–9].

Details of the method used in the AIMS project to determine dark spots are not published. Therefore, the ITS project team had to develop a new method to test blemishes in IITs.

Finding a solution to capture a sharp image from the surface of tested IITs was the first problem to be solved. It should be remembered that nowadays the majority of IITs is manufactured having the fiber optics screen curved. At the same time typical objectives for digital still cameras or video cameras are designed for the case of a flat area target. Therefore, typical digital cameras generate images of IITs with sharp centers but also with blurred edges. This problem has been solved by using a macro objective designed with intentionally high field curvature aberration.

Development of an effective, machine vision algorithm to detect, count and segregate dark spots in images generated by IITs has been a more difficult problem to be solved.

Dark spots in images are captured by high resolution digital still cameras for relatively large groups of pixels (typically over 100 pixels). Next, it is the case of a static image. Therefore, it looks relatively easy to develop machine vision algorithms to carry out automatic detection and recognition of dark spots in images generated by IITs. It can be expected that typical commercial machine vision systems used in millions in industry, medicine, agriculture should easily do such a task. However, practical experiments carried out with several machine vision systems offering possibility of searching targets similar to dark spots gave negative results.

These commercial machine vision systems failed due to several non-typical features of images from IITs: 1) images from IITs are many times more noisy than images from typical still cameras/video cameras captured at good illumination conditions; 2) dark spots in images from IITs are often strongly blurred; 3) bright areas can be several times brighter than dark areas; 4) fixed pattern noise looks similar to dark spots.

The project team have developed several computer algorithms based on advanced machine vision methods (neural networks, fuzzy logic, stochastic search), but the developed computer programs have not produced reliable measurement results. Therefore, finally a simpler but error-proof computer program based on classical image processing methods has been developed.

The SPOT computer program carries out analysis of still images of screens of IITs in several stages:

A. Image acquisition and preliminary analysis:

- 1) Acquisition of the image of IIT from a digital still camera.
- 2) Conversion of the color image to the monochrome one.
- 3) Binarization of the total image using criteria based on the image histogram.

B. Extraction of candidates for dark spots:

- 1) Determination and removal of dead background in the captured image.
- 2) Low frequency filtering and removal of the image non-uniformity (low frequency spatial noise).
- 3) The output image is the threshold and candidates for dark spots are determined.
- 4) The diameters of circular spots of area equal to the area of detected objects are calculated.
- 5) Objects with the diameter below the minimum one determined in MIL standards are removed from further analysis.

C. Determination of shape and contrast of detected objects:

- 1) Creation of an array of detected objects on local backgrounds.
- 2) Operation of selective erosion.
- 3) Selection of the proper dark spots using the contrast criterion.
- 4) Calculation of parameters of the detected dark spots: the spot area, the diameter of circle-equivalent area, the position of spot center.

- 5) Sorting of the detected and recognized dark spots according to rules from MIL standards or other regulations.

The image of an exemplary IIT with marked detected dark spots is shown in Fig. 7. The tube area is divided into sectors according to the MIL standard recommendations. Next, the results of sorting the detected spots according to their size and coordinates are presented in Fig. 8.

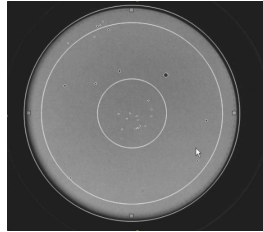

Fig. 7. The image of an exemplary tube with marked dark spots. The tube area is divided into sectors according to the MIL standard recommendations.

Spot size [μm]	< 5,6 mm (1)	5,6 < 14,7 mm (2)	14,7 < 17,5 mm (3)
< 75	7	54	14
75 < 150	2	14	3
150 < 230	0	1	0
230 < 300	1	0	0
300 < 380	0	0	0
> 380	0	0	0

Fig. 8. The table with dark spots sorted according to their size and location.

9. Conclusions

Image intensifier tubes are the most important component of NVDs used in big numbers in defense applications. Testing of IITs is still done mostly using manual methods due to a series of both technical and legal reasons. Computerized stations for semi-automated testing of IITs can be still considered as novelties and are under continuous improvements.

This paper presents a scientific project carried out with the aim to develop a computerized universal test station of ultra-wide test capabilities. A wide range of parameters that can be measured is the most significant advantage of the developed ITS-IP test station comparing to the current level of night vision metrology. A series of technical challenges that have been solved during the ITS project is described, too. Solutions used to solve these challenges are discussed in detail.

The developed ITS-IP test station can be considered as a significant progress in the direction of fully automatic, accurate test systems that are traceable to international metrological calibration systems. However, further research and improvements in both computerized test stations and calibration systems is needed in order to achieve this aim.

Acknowledgments

We inform that the research needed to obtain the results presented in this paper was partially financed by the grant from the National Center for Research and Development of Republic of Poland no ZPB/72/65585/IT2/10.

References

- [1] MIL-PRF-49052G. (1999). *Image intensifier assembly, 18 millimeter microchannel wafer, MX-9916/UV.*
- [2] MIL-PRF-49428. (1995). *Image intensifier assembly, 18 millimeter microchannel wafer, MX-10160/AVS-6.*
- [3] MIL-I-49453 CR. (1989). *Image intensifier assembly, 18 millimeter microchannel wafer, MX 10130/UV.*
- [4] MIL-PRF-49040F. (1992). *Image intensifier assembly, 25 millimeter microchannel inverter, MX-9644/UV.*
- [5] MIL-I-49043. (1995). *Image intensifier assembly 18 millimeter with automatic brightness control.*
- [6] MIL-I-49428. (1997). *Image intensifier assembly, 18 mm, microchannel wafer MX-10160/AVS-6.*
- [7] Alzman, D., Santor, M., Pecina, J., Paul, C., Helms, B. (1996). System for the automatic inspection of image intensifier tubes. Visual Information Processing V. *Proc. of SPIE*, 2753.
- [8] Alzman, D., *et al.* (2003). Machine vision image analysis capability for image intensifier tubes and systems. Low-Light-Level and Real-Time Imaging Systems. Components and Applications. *Proc. of SPIE*, 4796.
- [9] Partee, J., *et al.* (2008). Automated intensifier tube measuring system. Display Technologies and Applications for Defense, Security, and Avionics II. *Proc. of SPIE*, 6956.
- [10] <http://www.ncms.org/index.php/2010/08/automated-intensifier-measurement-system-aims-ribbon-cutting-ceremony> (Apr. 2015).
- [11] <http://www.ncms.org/index.php/portfolio/automated-intensifier-measurement-system-aims> (Apr. 2015).
- [12] <http://www.inframet.com/Data%20sheets/ITS-IP.pdf> (Apr. 2015).
- [13] <http://camerapedia.wikia.com/wiki/Helios-44> (Apr. 2015).
- [14] <http://www.photodo.com> (Apr. 2015).
- [15] <http://www.labsphere.com/uploads/datasheets/lr-systems-product-sheet.pdf> (Apr. 2015).
- [16] http://www.sbir.com/blackbody_vs.asp (Apr. 2015).
- [17] <http://www.ci-systems.com/integrating-sphere> (Apr. 2015).
- [18] <http://www.gigahertz-optik.de/144-0-ISS-8P.html> (Apr. 2015).
- [19] http://www.goochandhousego.com/wp-content/pdfs/466_B118_7_11_GH.pdf (Apr. 2015).
- [20] <http://www.inframet.pl/Data%20sheets/DAL.pdf> (Apr. 2015).
- [21] Chrzanowski, K., Raźniewski, T., Radzik, B. (2009). Monochromatic light sources in testing image in intensifier tubes. *Photonics Letters of Poland*, 79–81.
- [22] Voigt, D., Hagendoorn, I.A., van der Ham, E.W.M. (2009). Compact large-area uniform colour-selectable calibration light source. *Metrologia*, 46, S243.
- [23] Chrzanowski, K. (2015). Review of night vision metrology. *Optoelectronics Review*, 23(2), 149–164.
- [24] Illes, P. Csorba (1981). Modulation Transfer Function (MTF) Of Image Intensifier Tubes, Assessment of Imaging Systems II. *Proc. of SPIE*, 0274.
- [25] Williams, T.L. (1981). Modulation Transfer Function (MTF) System For Image Intensifier Units, Assessment of Imaging Systems II, 148. *Proc. of SPIE*, 0274.
- [26] Ortiz, S., Otaduy, D., Dorransoro, C. (2004). Optimum parameters in image intensifier MTF measurements, Elektro-Optical and Infrared Systems: Technology and Applications. *Proc. of SPIE*, 5612.
- [27] Ming, X., *et al.* (2007). MTF Measurement and analysis of Micro-channel Plate Image Intensifiers. *J. Acta Photonica Sinica*, 36(11), 1983–1987.
- [28] Su, J., *et al.* (2010). Measurement and analysis of modulation transfer function of the third generation low-light-level image intensifier. Optoelectronic Materials and Devices for Detector, Imager, Display, and Energy Conversion Technology. *Proc. of SPIE*, 7658.
- [29] Masaoka, K., Yamashita, T., Nishida, Y., Sugawara, M. (2014). Modified slanted-edge method and multidirectional modulation transfer function estimation. *Opt. Express*, 22.
- [30] www.oeggmbh.com/?p=12&k=43&l=1 (Apr. 2015).
- [31] www.image-science.com/products.htm (Apr. 2015).
- [32] Kuhls-Gilcrist, A., Jain, A., Bednarek, D.R., Hoffmann, K.R., Rubin, S. (2010). Accurate MTF measurement in digital radiography using noise response. *Med Phys.*, 37(2), 724–35.
- [33] Bender, E.J., *et al.* (2013). Characterization of domestic and foreign image intensifier tubes, Infrared Imaging Systems. Design, Analysis, Modeling and Testing XXIV. *Proc. of SPIE*, 8706.